

THIS DRAWING IS UNPUBLISHED.

RELEASED FOR PUBLICATION

20

© COPYRIGHT 20 BY -

ALL RIGHTS RESERVED.

LOC	DIST	REVISIONS					
		P	LTR	DESCRIPTION	DATE	DWN	APVD
-	-	D1		PARTS -2 -3 1-2 AND 1-3 RELEASED FOR PRODU	27OCT2013	KR	JC
		E		UPDATED DRAWING	19DEC2014	KR	MZ
		E1		REVISED PART NUMBERS	17JUL2017	SK	MZ
		E2		REVISED PER ECR-18-006945	20SEP2018	SR	MZ

NOTES:

- 1 MATERIAL: POLYAMIDE GLASS FILLED COLOUR NATURAL
- 2 MATERIAL: POLYAMIDE GLASS FILLED COLOUR BLACK
- 3) PACKAGING: SEE TE PACKAGING SPECIFICATION 107-20294
- 4 TE LOGO
- 5 N CODE
- 6 L CODE
- 7 PE CODE
- 8 RATED VOLTAGE
- 9 WIRE SIZE & RATED CURRENT
- 10 AREA FOR AGENCY APPROVAL LOGO
- 11 IP CODE
- 12) SOCKET CAP P/N 293596-1 (SEE DRAWING 293596 FOR REFERENCE) HAS TO BE ASSEMBLED TO GUARANTEE IP40 DEGREE OF PROTECTION WHEN CONNECTOR HOUSING IS NOT MATTED WITH COUNTERPART.
- 13 DATE CODE

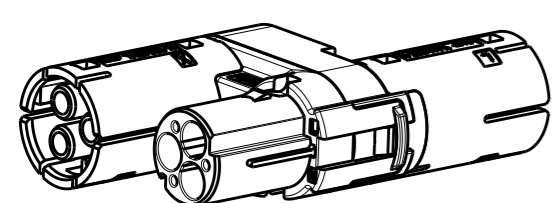
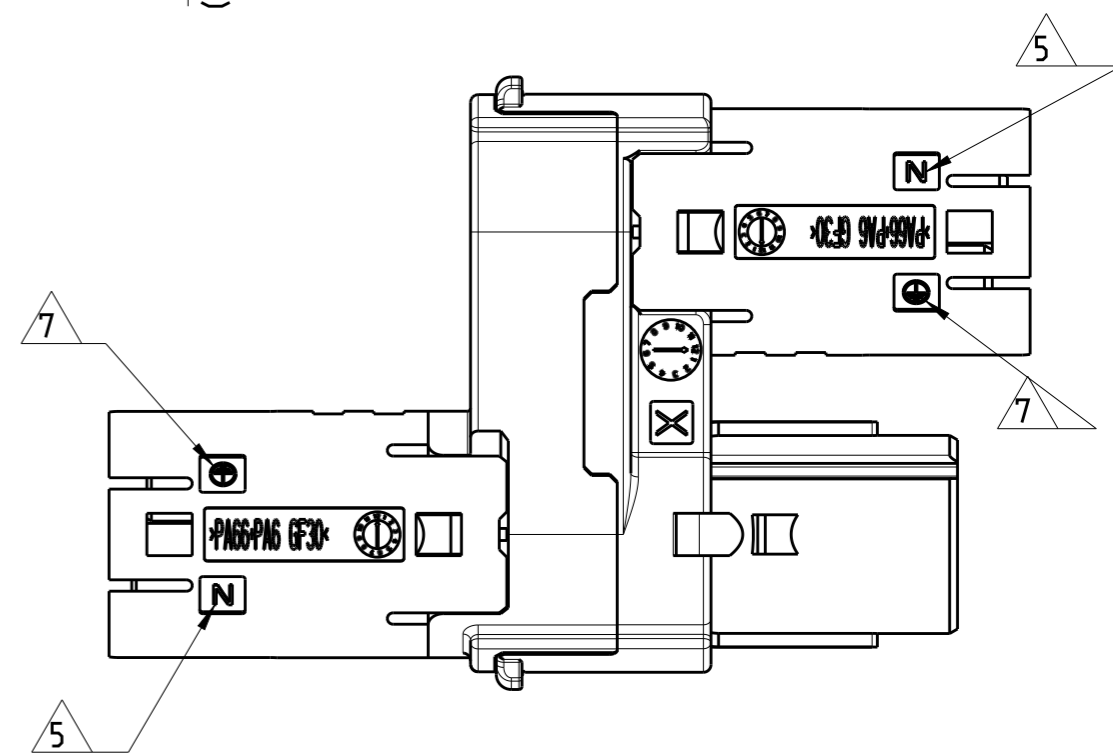
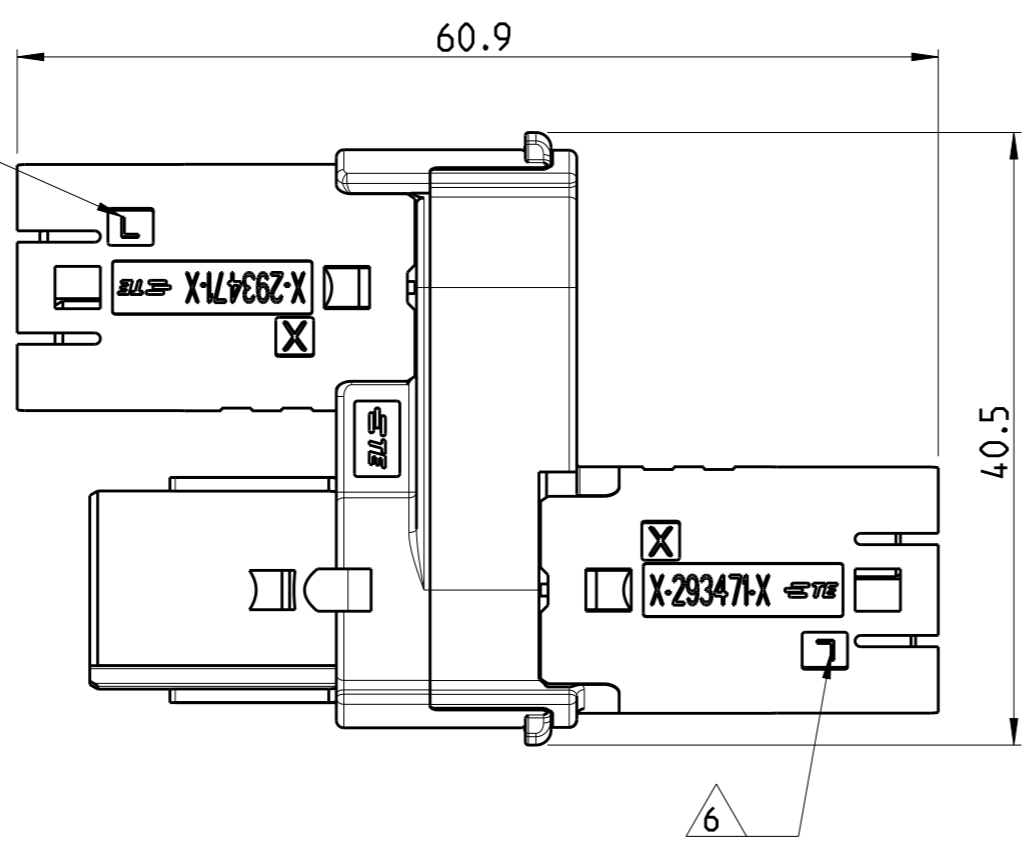
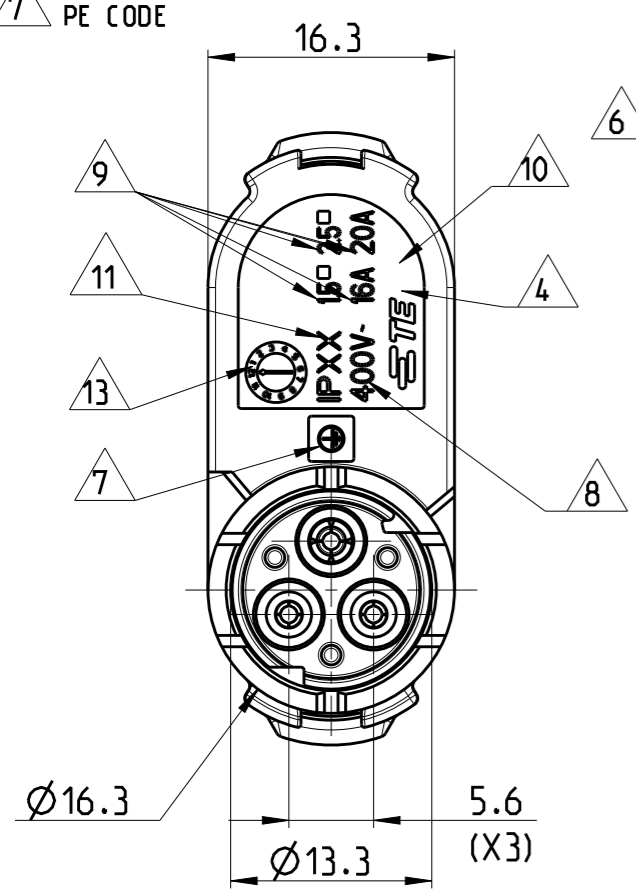
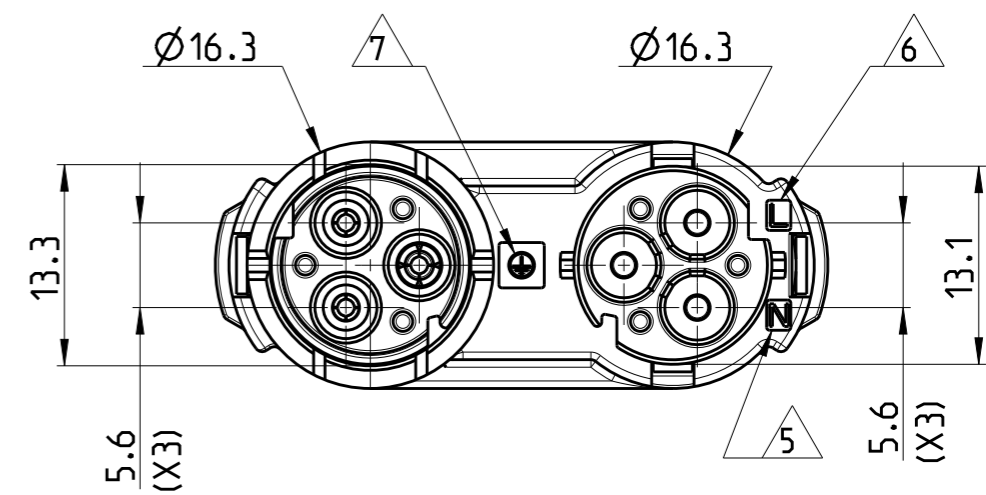

SCALE 1:1

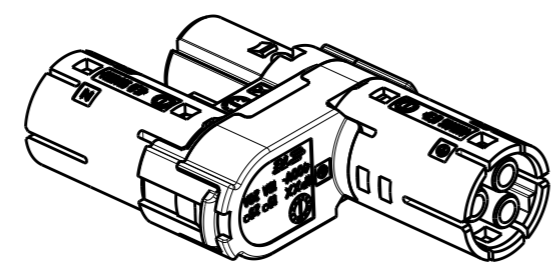

THIS DRAWING IS A CONTROLLED DOCUMENT.

DIMENSIONS:	TOLERANCES UNLESS OTHERWISE SPECIFIED:
mm	
	0 PLC ±0.3
	1 PLC ±0.20
	2 PLC ±0.20
	3 PLC ±0.20
	4 PLC ±0.20
	ANGLES ±3°
MATERIAL	FINISH
-	-

DWN	M. ZUCCA	06OCT2009
CHK	U. AIME	06OCT2009
APVD	G. TURCO	06OCT2009
PRODUCT SPEC	-	-
APPLICATION SPEC	-	-
WEIGHT	-	-

TE Connectivity		NAME	
		T-SPLITTER CONNECTOR NECTOR* M-LINE 3 POLES UNSEALED VERSION	
SIZE	CAGE CODE	DRAWING NO	RESTRICTED TO
A3	00779	C-293611	-

Customer Drawing	SCALE 2:1	SHEET 1 OF 2	REV E2
------------------	-----------	--------------	--------

THIS DRAWING IS UNPUBLISHED.

RELEASED FOR PUBLICATION

20

© COPYRIGHT 20 BY -

ALL RIGHTS RESERVED.

LOC	DIST	REVISIONS					
		P	LTR	DESCRIPTION	DATE	DWN	APVD
-	-		-	SEE SHEET 1	-	-	-

POLARIZATION TYPES

TYPE "A"

TYPE "B"

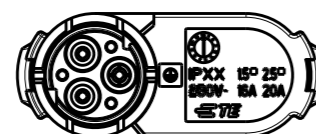
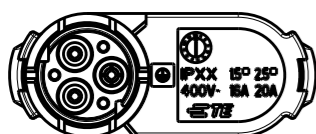
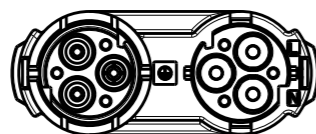
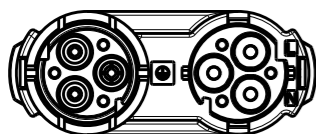

P/Ns: 293611-1,
1-293611-1

P/Ns: 293611-2,
1-293611-2

TYPE "C"

TYPE "D"

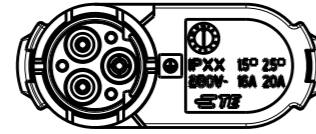
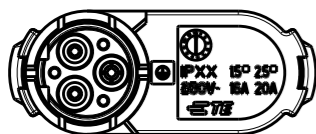
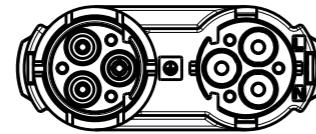
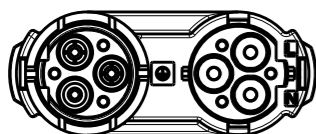

P/Ns: 293611-3,
1-293611-3

~~P/Ns: 293611-4,
1-293611-4~~

OBSOLETE		UNSEALED	B	BLACK	T-SPLITTER CONNECTOR NECTOR* M-LINE	C	1-293611-4
		UNSEALED	C	BLACK	T-SPLITTER CONNECTOR NECTOR* M-LINE	E	1-293611-3
		UNSEALED	B	BLACK	T-SPLITTER CONNECTOR NECTOR* M-LINE	E	1-293611-2
		UNSEALED	A	BLACK	T-SPLITTER CONNECTOR NECTOR* M-LINE	E	1-293611-1
OBSOLETE		UNSEALED	B	NATURAL	T-SPLITTER CONNECTOR NECTOR* M-LINE	C	293611-4
		UNSEALED	C	NATURAL	T-SPLITTER CONNECTOR NECTOR* M-LINE	E	293611-3
		UNSEALED	B	NATURAL	T-SPLITTER CONNECTOR NECTOR* M-LINE	E	293611-2
		UNSEALED	A	NATURAL	T-SPLITTER CONNECTOR NECTOR* M-LINE	E	293611-1
NOTE	VERSION	POL. KEYING	COLOUR	DESCRIPTION	REV.	PART NUMBER	

THIS DRAWING IS A CONTROLLED DOCUMENT.		DWN M. ZUCCA 06OCT2009	TE Connectivity		
DIMENSIONS: mm		CHK U. AIME 06OCT2009			
TOLERANCES UNLESS OTHERWISE SPECIFIED:		APVD G. TURCO 06OCT2009	NAME T-SPLITTER CONNECTOR NECTOR* M-LINE 3 POLES UNSEALED VERSION		
		PRODUCT SPEC -	RESTRICTED TO		
MATERIAL -		APPLICATION SPEC -	SIZE A3	CAGE CODE 00779	DRAWING NO C-293611
FINISH -		WEIGHT -	SCALE 1:1		
		Customer Drawing		SHEET 2 OF 2	
				REV E2	